

Weatherproof telephone wFT3

# FernTel 3



Operating manual



## Note

Please read the operating manual carefully before installing the device.  
Please check the contents of the box for completeness.

## Table of Contents

<b>General operating notes</b> .....	4
<b>Device overview / Dimensions</b> .....	5
<b>Device versions</b> .....	5
<b>Controls and indicators</b> .....	6
Version with keypad (21 keys) and display .....	6
Version with keypad (16 keys), without display .....	7
Version without keypad, without display .....	7
<b>As-delivered condition</b> .....	8
Box contents .....	8
Telephone presetting .....	8
<b>Mounting and installing</b> .....	9
Wall version .....	9
Table version .....	10
Mounting the sling holder .....	11
Connection of a secondary sounder .....	11
<b>Operation and programming</b> .....	12
<b>Version with keypad (21 keys) and display</b> .....	12
<b>Operation</b> .....	12
Seize (Make / answer a call) .....	12
Receiver volume .....	12
Make a call .....	12
Speed code dialling .....	12
Number redial .....	12
Disconnect .....	12
Enquiry call (dual-tone multifrequency only) .....	12
Telephone book .....	12
<b>Programming</b> .....	13
Telephone book .....	14
Speed code dialling .....	14
Settings .....	15
Ringing signal .....	15
Volume .....	15
Dialling mode .....	15
PBX .....	15
As-delivered condition .....	15
Menu .....	15
Restrictions .....	15
Activate .....	15
None .....	15

Direct call .....	16
Total lock .....	16
Telephone book .....	16
Programming .....	16
Direct call number .....	16
PIN .....	16
<b>Version with keypad (16 keys), without display .....</b>	<b>17</b>
<b>Operation .....</b>	<b>17</b>
Seize (Make / answer a call) .....	17
Amplified listening in receiver .....	17
Make a call .....	17
Last number redial .....	17
Disconnect .....	17
Enquiry call (dual-tone multifrequency only) .....	17
<b>Programming .....</b>	<b>17</b>
Allow settings modifications .....	17
Restrict settings modifications .....	18
Adjust ringing volume .....	18
Adjust the ringing melody .....	18
Amplified listening in receiver, setting the levels .....	18
Set dialling mode .....	19
Enter the exchange code .....	19
Delete the exchange code .....	19
Program pause following the exchange code .....	20
Program the Enquiry Key (flash time) .....	20
Restore to as-delivered condition .....	20
Change Personal Identification Number (PIN) .....	21
<b>Signalling tones during programming .....</b>	<b>21</b>
<b>Version without keypad and without display .....</b>	<b>22</b>
<b>Operation .....</b>	<b>22</b>
Seize (Make / answer a call) and dialling .....	22
<b>Programming using device-internal programming keypad (opt) .....</b>	<b>22</b>
Setting operating mode .....	22
Enter speed code dialling number .....	22
Adjust ringing volume .....	22
Adjust the ringing melody .....	23
Set dialling mode .....	23
Restore to as-delivered condition .....	23
<b>Signalling tones during programming .....</b>	<b>23</b>
<b>General information .....</b>	<b>24</b>
<b>Service .....</b>	<b>24</b>
<b>Care and maintenance .....</b>	<b>24</b>
<b>Warnings and security information .....</b>	<b>24</b>
<b>Technical Data .....</b>	<b>25</b>
<b>EC Declaration of Conformity .....</b>	<b>26</b>

## General operating notes

1. The versions of FernTel 3 can be operated in the analogue, public telephone network and connected to analogue terminals of branch exchanges.
2. The receiver is equipped with a leakage field spool for coupling of hearing aids. Users of a hearing aid with inductive receiver may receive the signal from the receiver inset directly.
3. The version without keypad does not offer you all the performance features available in other versions.
4. The telephone has a receiver accommodation with a magnetic contact as hook switch. To terminate an existing connection, the receiver must be replaced. For disconnecting an existing connection, all you need to do is press the disconnect key on the keypad.
5. When programming the settings, the handset must be off the hook. On the version with 16 keys, you enter programming mode by simultaneously pressing the asterisk and the hash key. For the version with 21 keys and a display, programming takes place in the Select menu, which appears when the ► key is pressed.
6. If a procedure has been completed successfully, you will hear an acknowledgement signal. An error tone informs you of any operating mistakes.
7. Should more than 2 minutes pass before you start dialling, the exchange may cut off the power supply. The dial tone can no longer be heard. In this case you should put the handset back on the hook and wait approximately 2 seconds before you lift it again. Programming sessions that have been started, but have not been completed, must be repeated.
8. If you get a call, the FernTel 3 rings with the volume and melody you have chosen. The display version also signals the incoming call in the display.
9. Entering your personal identification number (PIN) you may partly or completely restrict functions and settings. Forgetting your PIN can be compared to losing a key. If you have forgotten your PIN, please contact our technical support service.

## Device overview / Dimensions (mm / inch)

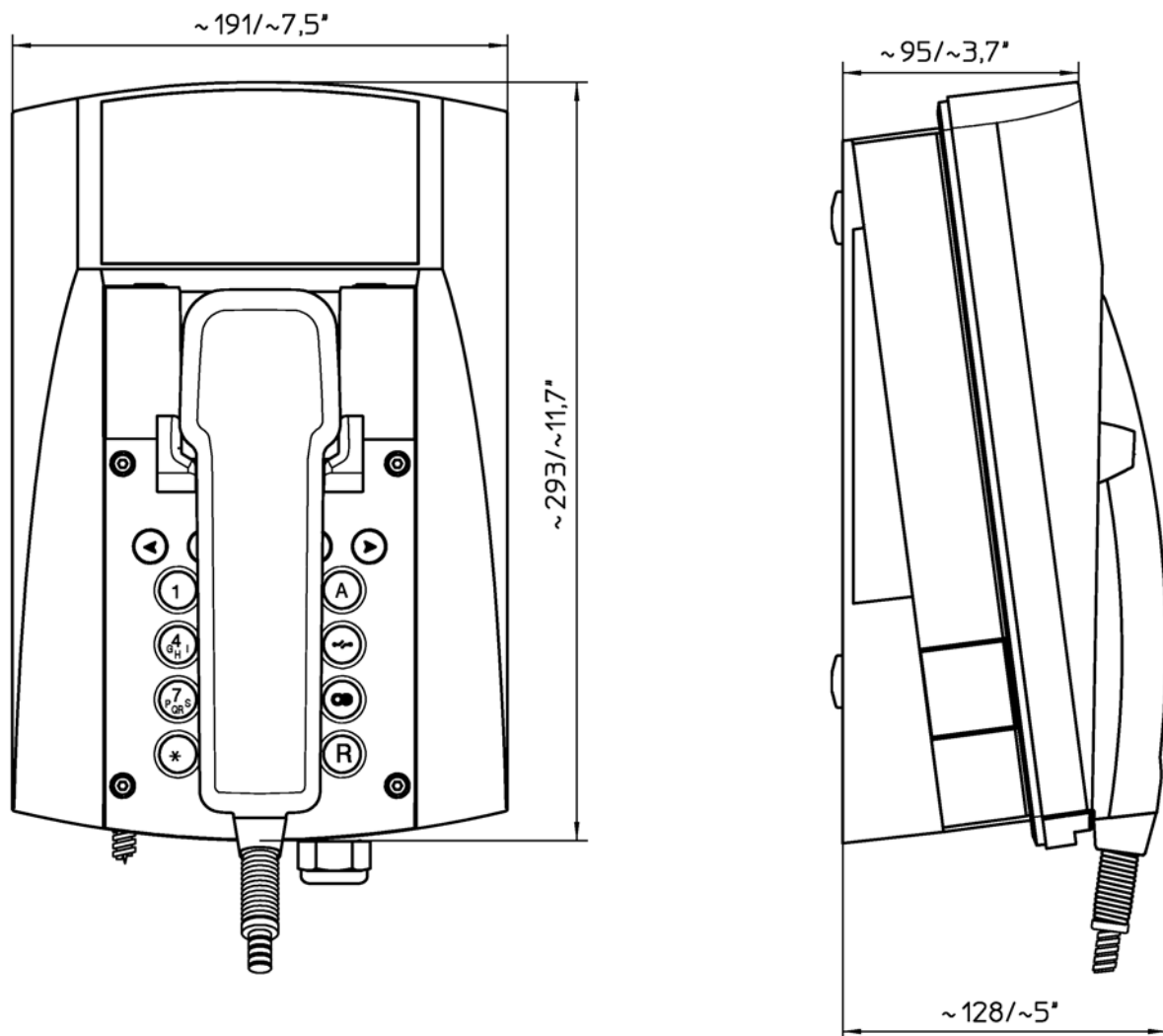

## Device versions

The telephone FernTel 3 is available in three versions.

- with keypad (21 keys) and display
- with keypad (16 keys), without display
- without keypad, without display (optionally with a device-internal programming keypad)

# Controls and indicators

## Version with keypad (21 keys) and display

Keypad

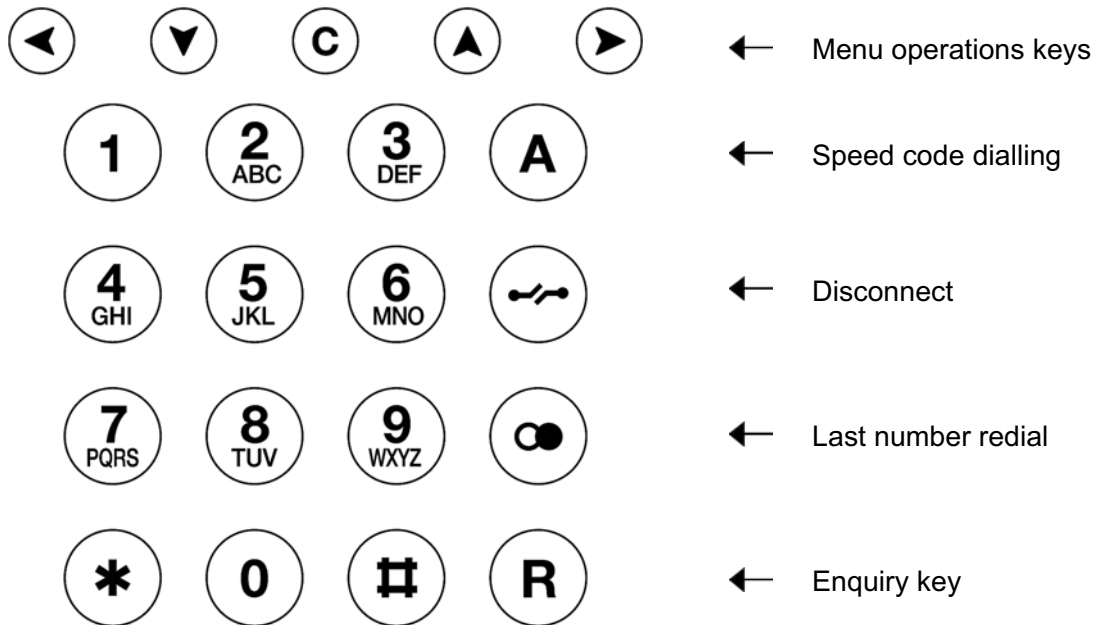

Number keys

Display

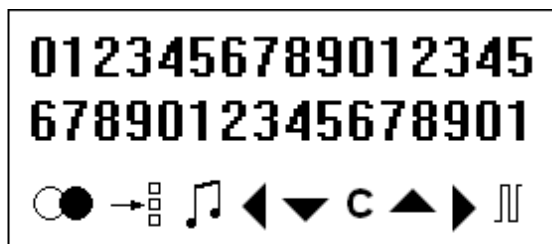

The two uppermost lines display numbers or the menu settings. The lower line displays pictograms that correspond to the functions.



Last number redial



Direct dialling



Dual-tone multifrequency (DTMF)



Pulse dialling

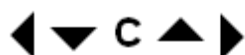

Menu operation

## Version with keypad (16 keys), without display

Keypad

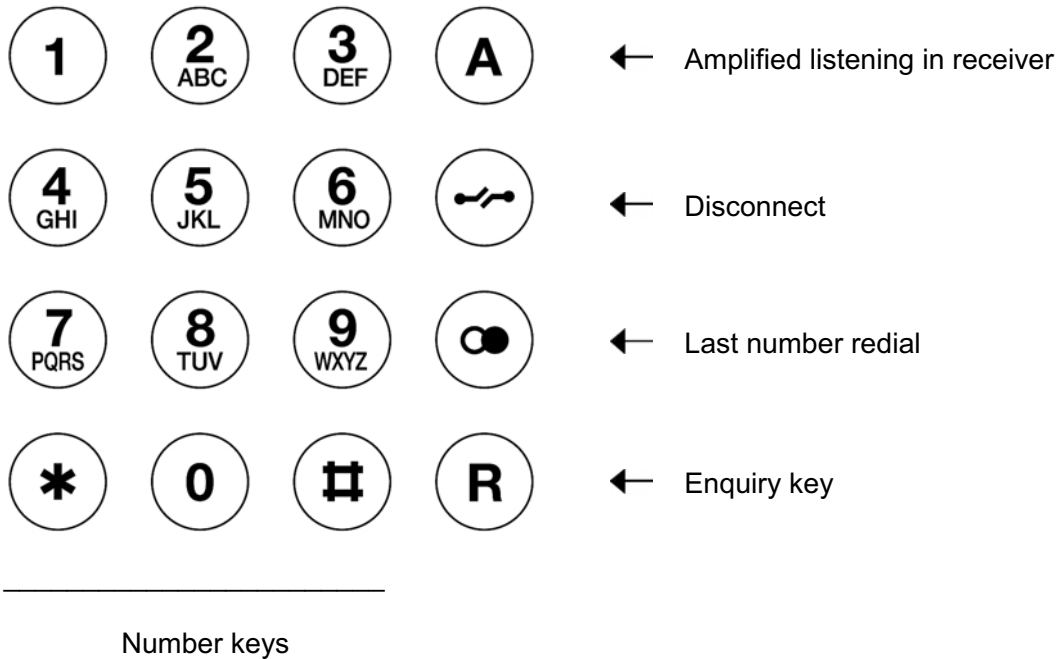

## Version without keypad, without display

Optional, device-internal programming keypad (12 keys)

1	2	3
4	5	6
7	8	9
*	0	#

## As-delivered condition

### Box contents

The scope of the delivery includes:

- 1 telephone
- 1 telephone mount
- 1 handset accommodation for the table version with 2 screws
- 4 washers Ø 18 mm
- this operating manual

### Telephone presetting

Dialling mode	Dual-tone multifrequency (DTMF), signal duration 90 ms
Enquiry key function (R key)	Flash 120 ms
Exchange code	none
Pause following exchange code	3 seconds
Last number redial memory	Empty
Speed code dialling memory	Empty
Direct call memory	Empty
Restrictions	Programming restricted
Amplified listening in receiver	Two levels (6 dB / 12 dB)
PIN	0000
Ringing melody	7
Ringing volume	6 = max
Receiver volume	1 = min, default value

Valid for version		
A	B	C
x	x	x
x	x	
x	x	
x	x	
x		
x		
x	x	
	x	
x	x	
x	x	x
x	x	x
x		

**A)** with keypad (21 keys) and display

**B)** with keypad (16 keys), without display

**C)** without keypad, without display (optionally with a device-internal programming keypad)

Using the programming menu, you may reset this as-delivered condition at any time. The PIN and the menu language, however, will not be altered by resetting.

## Mounting and installing

Protect the telephone from direct rays of the sun and sources of heat.

### Wall version

Fasten the telephone mount with 4 screws **(2)**. Place the provided washers  $\varnothing$  18 mm under the screw head.

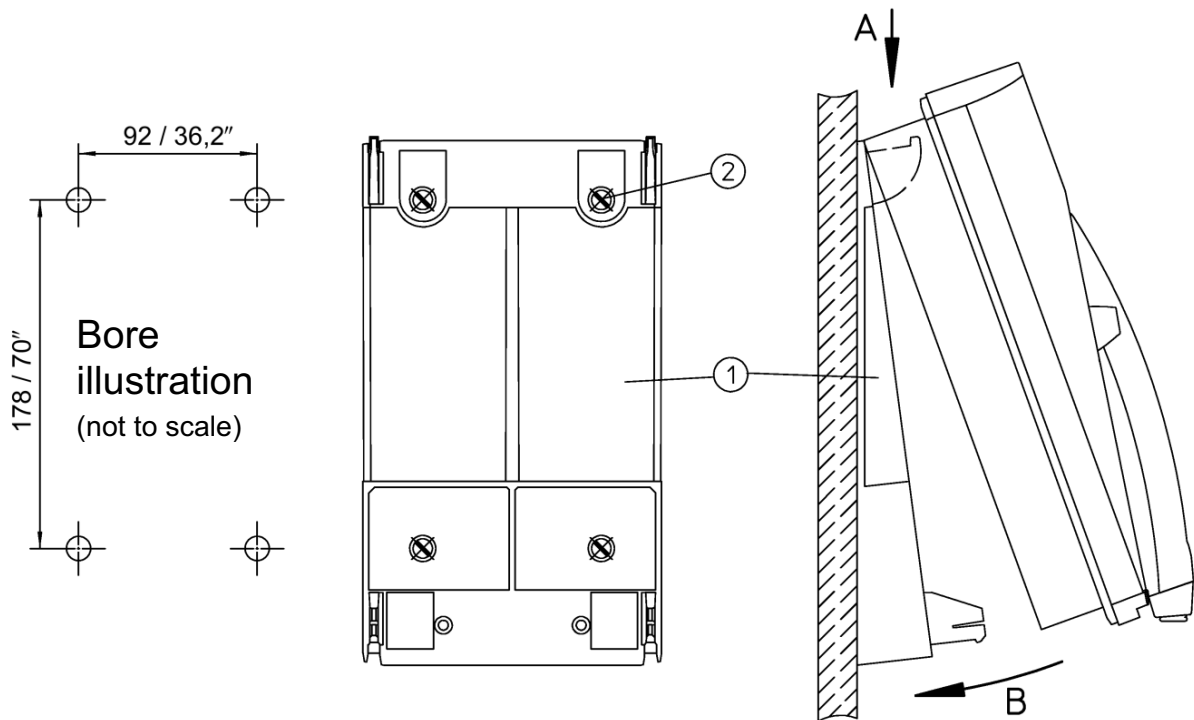

Place the telephone in the upper latches **(A)**, swing it downwards until the lower latches audibly engage **(B)**.

Remove the keypad plate **(6)**, and tighten the two locking screws **(3)** as far as they will go. Important: This preserves the IP65 degree of protection.

Pull the telephone line through the cable gland **(4)** and connect it with terminal **(5)** TCP/La - TCP/Lb (TCP : Terminal Connection Point).

Use cables with a sheath diameter of 5 to 9 mm only, otherwise the IP65 degree of protection can not be guaranteed.

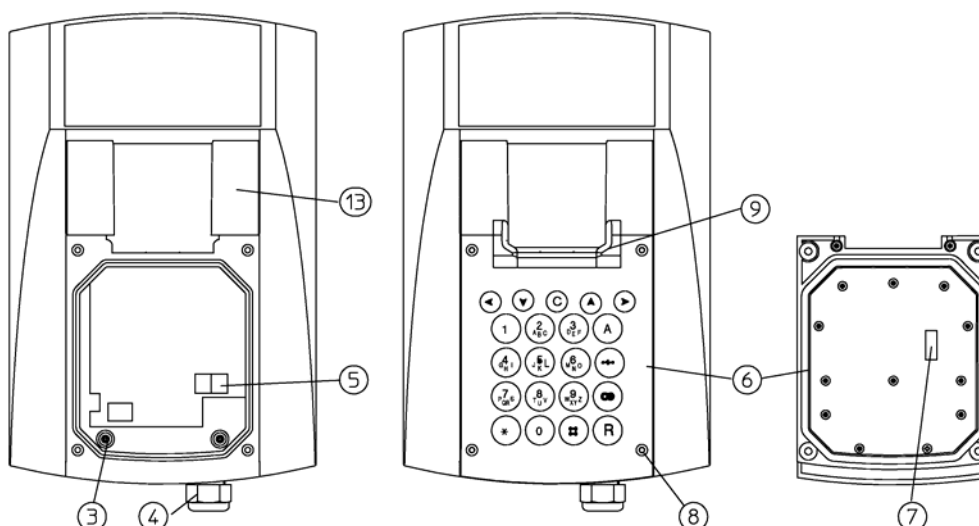

Plug the ribbon cable onto the pin contact strip (7) of the keypad plate. Tighten the keypad plate (6) using four screws (8).

### Table version

Place the telephone in the lower latches (A), swing it backwards until the upper latches audibly engage (B).

Pull the telephone line through the cable gland (4) and connect it with terminal (5) TCP/La - TCP/Lb.

Use cables with a sheath diameter of 5 to 9 mm only, otherwise the IP65 degree of protection can not be guaranteed.

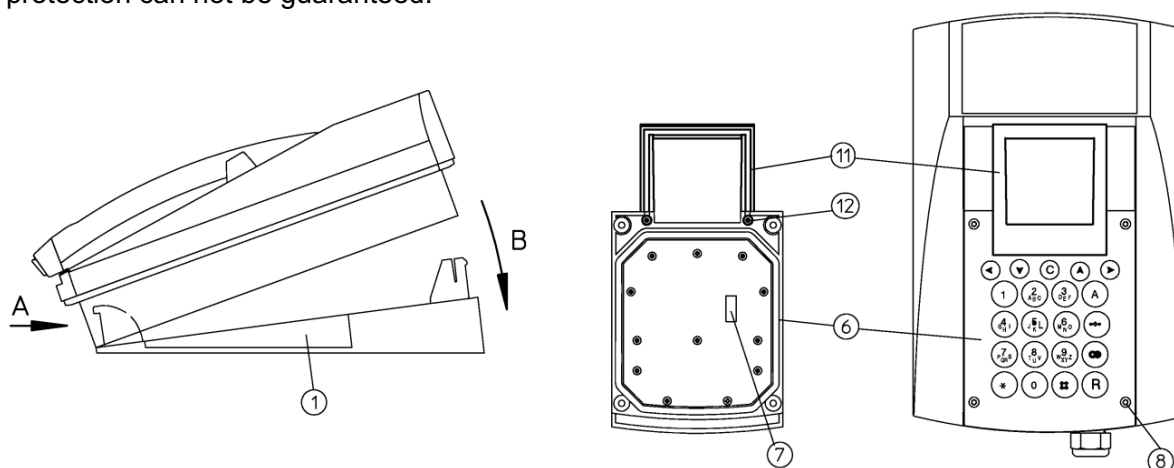

The standard handset accommodation (for the wall version) (9) can be replaced for the table version.

After loosening the two screws (12) on the bottom of the keypad plate you can remove the standard handset accommodation.

Fasten the table version handset accommodation (11) to the keypad plate by using the included screws (12).

Plug the ribbon cable onto the pin contact strip (7) of the keypad plate. Tighten the keypad plate (6) using four screws (8).

Lay the telephone cord according to the instructions, in order to prevent accidents.

## Mounting the sling holder (optional)

Remove the keypad plate (6) by loosening the screws (8).

Lever out the duct cover (13).

Fasten the sling holder (14) by using the two included screws (15).

Insert the duct cover (16) with groove.

Screw the keypad plate (6) back on again.

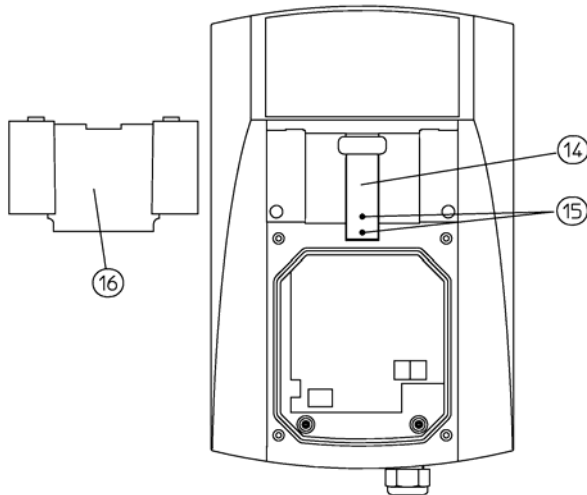

## Connection of a secondary sounder

If you want the telephone to control a secondary sounder, the blind plug must be replaced by a cable gland M20x1.5 IP65. The cable diameter must correspond to the demands of the cable gland, otherwise the IP degree of protection will not be reached. Remove the keypad plate, install the cable gland and connect the secondary sounder to the terminals W and W1. After all the connections are made, screw the keypad plate onto the housing again, using 4 screws (8).

# Operation and programming

## Version with keypad (21 keys) and display

### Operation

#### Seize (Make / answer a call)

When you pick up the handset, you may answer a call or make a call to a conversation partner.

#### Receiver volume

During a call you can adjust the volume in the receiver for the duration of the call, using the keys ▼ and ▲. If you want to change the receiver volume permanently, please use the programming menu „Settings/Receiver volume“

#### Make a call

Dial the desired number by using the number keys. When using the dialling mode Pulse dialling, the asterisk and hash keys have no function.

#### Speed code dialling

By pressing the A key, a pre-programmed number can be dialled automatically.

#### Last number redial

By pressing the last number redial key, the last entered number is automatically dialled.

#### Disconnect

To end a call and start a new call immediately afterwards, there is no need to put the handset down, just press the disconnect key. When disconnecting, the old call ends, and after a short while you hear the dialling tone. You may now enter the number for the new call.

#### Enquiry call (dual-tone multifrequency only)

If the telephone is connected to a private branch exchange, you may press the enquiry key R in order to establish a connection with another subscriber, who is also connected to the private branch exchange. By pressing this key a second time, you will be connected with the first subscriber again.

#### Telephone book

You can dial numbers from the telephone book. Pick up the handset and press the ► key. „Telephone book“ appears in the display. If you press the ► key again, the first of the stored names is shown. Using the keys ▼ and ▲ you can scroll to the name you want on the display. If you press the ► key, the number associated with the displayed name is dialled. („Telephone book“ appears in the display only if the telephone book contains one or more entries.)

# Programming



**In order to program the telephone, you have to allow modifications of the settings.**

## General

Use the Programming menu to modify the operating settings of the telephone. After lifting the handset or pressing the disconnect key, a welcome message appears in the display.

Begin the programming procedure by pressing the ► key.

In the top line of the display, the text „Main menu“ appears. In the second line, you see the first menu item of the Main menu. The arrow > in front of the menu item indicates that this item has been selected. Provided you have access to other menu items, pressing the ▼ key takes you to the next menu items, one at a time. Pressing the ▲ key takes you back to the top of the list of menu items.

The display shows a maximum of two menu items. When an arrow > is visible in front of an item, it indicates that the item has been selected. The menu items denote further sub-menus.

Pressing the ► key activates a selected menu item.

Any sub-menu may contain further sub-menus as menu items. These sub-menus are selected in the same manner as in the Main menu. Press the ◀ key to go to a higher menu, or to leave the Main menu.

At the lower menu levels, so-called radio buttons are displayed for the selection of possible settings.

Example:

Display	Significance
---Activate---	Title line
( ● ) None	Activated option
(   ) Direct call	Option
>(   ) No calls	Selected option
=== End===	End of menu list

Pressing the C key activates a selected option.

In certain menus, values may be changed. These changes are made by pressing the ▼ and ▲ keys.

For all programming goes: Changes are applied and stored upon pressing the ► key only.

By pressing the ◀ key, you leave the menu without applying the changes.

If a programming session has not been completed, the telephone leaves the Programming menu after a certain amount of time (time-out).

If you want to modify the settings, you will be required to enter a four-digit PIN. The PIN set by the factory is 0000.

## Initial programming

In the as-delivered condition, the telephone already has a basic configuration enabling you to make and answer calls. If you want certain settings regarding telephone book entries, volume, dialling mode, or operation from private branch exchanges, you must use the Programming menu.

Press the ► key to go to the Main menu.

The sub-menu „Programming“ appears. Pressing the ► key takes you to the next level, where you may activate the sub-item „allow“ by pressing the C key. You will be prompted to enter the PIN (factory setting 0000). Programming is now allowed, and the complete Main menu is at your disposal, including the following items:

- Telephone book
- Speed code dialling A
- Settings

- Restrictions
- Programming

Press the ► key to select a menu item.

## Telephone book

In the telephone book, you press the ▼ and ▲ keys to display the entered names (and numbers). Press the ► key to choose between the following sub-menus:

- dial
- modify
- add
- delete
- delete all

In case of an empty telephone book, only the sub-menu „add“ appears.

For using the menus „add“, „modify“, „delete“, „delete all“, you are also required to enter the PIN.

How it works

dial

The number stored with the displayed name is dialled.

add

A new telephone book entry is added to the telephone book.

modify

Names and number of the displayed telephone book entry is modified.

delete

The displayed telephone book entry is deleted.

delete all

All entries of the telephone book are deleted.

## Speed code dialling A

Under Speed code dialling you can program a number to be dialled automatically when the A key is pressed.

## Settings

Under Settings, use the ▼ and ▲ keys to display the following sub-menus:

- Ringing signal
- Volume
- Dialling mode
- PBX
- Menu
- As-delivered condition
- PIN

### Ringing signal

The volume and melody of the ringing signal are set.

### Volume

The receiver volume is set permanently.

### Dialling mode

Here, one of four dialling modes is selected. The options are:

- Dual-tone multifrequency (DTMF) with a tone duration of 90 ms
- Dual-tone multifrequency (DTMF) with unlimited tone duration (corresponding to key usage)
- Pulse dialling (PD) pulse duty ratio 1.5:1
- Pulse dialling (PD) pulse duty ratio 2:1

### PBX

If the telephone is connected to a private branch exchange, this is where you perform the following settings:

- Enter or delete an exchange code
- The duration of the pause following the exchange code
- The flash time upon operation of the enquiry key (dual-tone multifrequency dialling only)

### Menu

Here you can set the menu language, the welcome message and the display contrast.

### As-delivered condition

The as-delivered condition is reset. This will not alter the PIN or the menu language.

### PIN

Here you may change the 4-digit PIN. The PIN is 0000 upon delivery.

## Restrictions

Under Restrictions, use the ▼ and ▲ keys to display the following sub-menus:

- Activate
- Direct call number

### Activate

Choose from

- none  
The telephone is not restricted.
- Telephone book  
Numbers can be dialled from the telephone book only.
- Direct call  
When pressed, all keys except the Disconnect key and the ◀ key dial the direct call number.



## Version with keypad (16 keys), without display

### Operation

#### Seize (Make / answer a call)

When you pick up the handset, you may answer a call or make a call to a conversation partner.

#### Amplified listening in receiver

Press the A key to increase the receiver volume during a call. Depending on the presetting, the volume is increased in one or two steps. Pressing the A key one more time reduces the volume to the previous level.

#### Make a call

Dial the desired number by using the number keys. When using the dialling mode Pulse dialling, the asterisk and hash keys have no function.

#### Last number redial

By pressing the last number redial key, the last entered number is automatically dialled.

#### Disconnect

To end a call and start a new call immediately afterwards, there is no need to put the handset down, just press the disconnect key. When disconnecting, the old call ends, and after a short while you hear the dialling tone. You may now enter the number for the new call.

#### Enquiry call (dual-tone multifrequency only)

If the telephone is connected to a private branch exchange, you may press the enquiry key R in order to establish a connection with another subscriber, who is also connected to the private branch exchange. By pressing this key a second time, you will be connected with the first subscriber again.

### Programming



In order to program the telephone, you have to allow modifications of the settings.

#### Allow settings modifications

- Lift the handset.
- Press the \* and # keys simultaneously.
- Press the # and 0 keys consecutively.
- Enter the PIN
- Press the  key to allow settings modifications.
- Replace the handset.



## Restrict settings modifications

- Lift the handset.
- Press the \* and # keys simultaneously.
- Press the # and 1 keys consecutively.
- Enter the PIN
- Press the  key to disable settings modifications.
- Replace the handset.



## Adjust ringing volume

- Lift the handset.
- Press the \* and # keys simultaneously.
- Press key 5 (the ringing sound is played back with the selected volume setting).
- Set the desired volume using the keys 1 to 6.
- Press the  key to store the selected volume.
- Replace the handset.

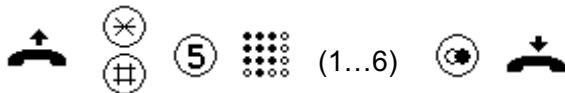

## Adjust the ringing melody

- Lift the handset.
- Press the \* and # keys simultaneously.
- Press key 6 (the set melody is played back)
- Set the desired melody using the keys 1 to 9.
- Press the  key to store the selected melody.
- Replace the handset.

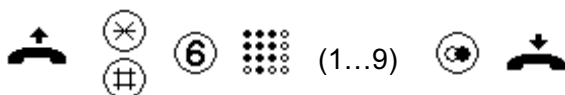

## Amplified listening in receiver, setting the levels

- Lift the handset.
- Press the \* and # keys simultaneously.
- Press key 2.
- Set the code for the desired number of levels, or steps.
- Press the  key to store the setting.
- Replace the handset.

Code / Key	Amplified listening in receiver, levels	Comment
1	1 level, 6 dB	
2	2 levels, 6 dB, 12 dB	As-delivered condition

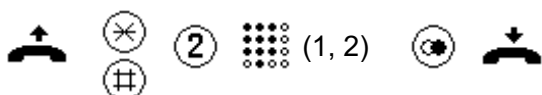

## Set dialling mode

- Lift the handset.
- Press the \* and # keys simultaneously.
- Press key 9.
- Enter the code for the desired dialling mode.
- Press the  key to store the selected dialling mode.
- Replace the handset.

Code / Key	Dialling mode	Comment
1	Dual-tone multifrequency (DTMF), unlimited tone duration	The DTMF tone is being generated as long as the associated key is being pressed.
2	Dual-tone multifrequency (DTMF), tone duration 90 ms	As-delivered condition
3	Pulse dialling (PD), 1.5:1	
4	Pulse dialling (PD), 2:1	

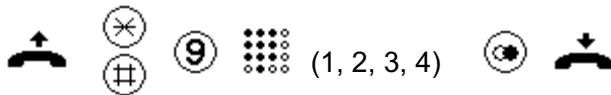

## Enter the exchange code

- Lift the handset.
- Press the \* and # keys simultaneously.
- Press key 0.
- Enter the exchange code (a digit or the R key;\* and # not allowed)
- Press the  key to store the entered exchange code.
- Replace the handset.

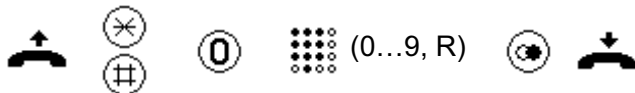

## Delete the exchange code

- Lift the handset.
- Press the \* and # keys simultaneously.
- Press key 0.
- Press the # key.
- Press the  key to delete.
- Replace the handset.

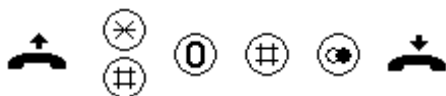

## Program the pause following the exchange code

- Lift the handset.
- Press the \* and # keys simultaneously.
- Press key 1.
- Press a key from 1 to 5 (the key number corresponds to the duration in seconds)
- Press the  key to store the entered duration of the pause.
- Replace the handset.

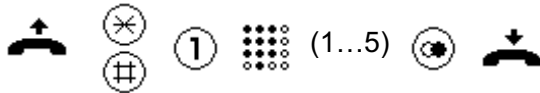

## Program the Enquiry Key (flash time)

For dual-tone multifrequency only. Pressing the enquiry key briefly interrupts the loop to the private branch exchange (flash) to enable an enquiry to another private branch connection. The flash time is programmable.

- Lift the handset.
- Press the \* and # keys simultaneously.
- Press key 8.
- Enter the code for the desired flash time.
- Press the  key to store the selected flash time.
- Replace the handset.

Code / Key	Flash time	Comment
1	80 ms	
2	120 ms	As-delivered condition
3	600 ms	

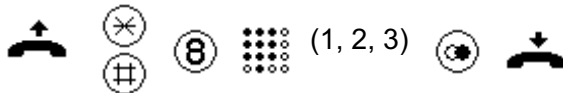

## Restore to as-delivered condition

- Lift the handset.
- Press the \* and # keys simultaneously.
- Press key 3.
- Press the  key to reset the as-delivered condition.
- Replace the handset.

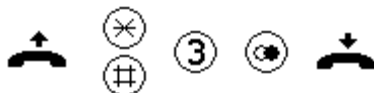

Upon „Resetting to the as-delivered condition“ the PIN is **not** reset to 0000.

## Change Personal Identification Number (PIN)

- Lift the handset.
- Press the \* and # keys simultaneously.
- Press the # and 2 keys consecutively.
- Enter the old PIN.
- Enter new PIN.
- Repeat new PIN.
- Press the  key to store the new PIN.
- Replace the handset.

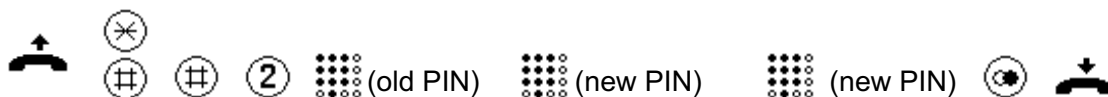

## Signalling tones during programming

<b>Tone</b>	<b>Number</b>	<b>Significance</b>
Acknowledgement tone	1 long tone	Completion of a correctly performed procedure.
Error tone	4 short tones	An error occurred within a procedure. The procedure is cancelled.
PIN tone	1 short tone sequence	Prompt to enter the PIN.

## Version without keypad and without display

### Operation

#### Seize (Make / answer a call) and dialling

Receive a call by lifting the handset. If you want to make a call, lift the handset. The private branch exchange then automatically establishes a connection.

#### Optionally

If you have a telephone with a built-in programming keypad, you may program a speed code dialling number. When the handset is lifted, this programmed number is then dialled automatically. This operating mode is set using the programming keypad.

### Programming using the device-internal 12-key programming keypad

#### Setting operating mode

- Lift the handset.
- Press the \* key.
- Enter the operating mode code.
- Press the # key to store the selected operating mode.
- Replace the handset.

Code / Key	Operating mode	Comment
1	Normal telephone, dialling by private branch exchange	As-delivered condition
4	Automatic speed dialling	

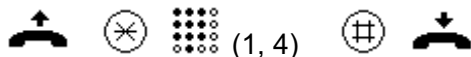

#### Enter speed code dialling number

- Lift the handset.
- Press the \* key.
- Press the # key.
- Enter speed code dialling number
- Press the # key to store the speed code dialling number.
- Replace the handset.

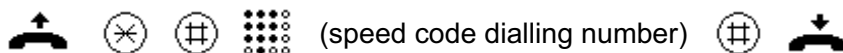

#### Adjust ringing volume

- Lift the handset.
- Press the \* key.
- Press key 5 (the ringing sound is played back with the selected volume setting).
- Set the desired volume using the keys 1 to 6.
- Press the # key to store the selected volume.
- Replace the handset.

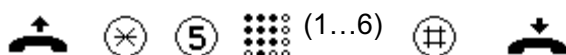

## Adjust the ringing melody

- Lift the handset.
- Press the \* key.
- Press key 6 (the set melody is played back)
- Set the desired melody using the keys 1 to 9.
- Press the # key to store the selected melody.
- Replace the handset.



## Set dialling mode

- Lift the handset.
- Press the \* key.
- Press key 9.
- Enter the code for the desired dialling mode.
- Press the # key to store the selected dialling mode.
- Replace the handset.

Code / Key	Dialling mode	Comment
1	Dual-tone multifrequency (DTMF), unlimited tone duration	The DTMF tone is being generated as long as the associated key is being pressed.
2	Dual-tone multifrequency (DTMF), tone duration 90 ms	As-delivered condition
3	Pulse dialling (PD), 1.5:1	
4	Pulse dialling (PD), 2:1	

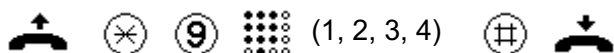

## Restore to as-delivered condition

- Lift the handset.
- Press the \* key.
- Press key 3.
- Press the # key to reset the as-delivered condition.
- Replace the handset.



## Signalling tones during programming

Tone	Number	Significance
Acknowledgement tone	1 long tone	Completion of a correctly performed procedure.
Error tone	4 short tones	An error occurred within a procedure. The procedure is cancelled.

## General information

### Service

You have bought a modern J. Auer product subject to meticulous quality control. If any questions regarding the telephone, or malfunctions should occur – even after the guarantee has expired - please contact J. Auer. Please have the type denomination and product number (to be found on the nameplate) ready.

### Care and maintenance

The telephone is maintenance-free. Still, if the operating area is highly contaminated by dust, fat, oil etc., the device should be cleaned from time to time. Use a moist cloth to dust off the handset and the device.

Warning! Never use sharp objects for cleaning. Do not use other polishing or abrasive substances.

### Warnings and security information

This device is a weatherproof telephone especially designed for use in rugged industrial environments. Please note the following warnings and security information:

1. The telephone is a Insulation Class II device and may only be connected to and operated at the voltage it was designed for. Make sure the connections are in perfect order. The connecting cable must be laid in a manner not to cause a tripping hazard.
2. The telephone may only be operated at the given ambient conditions (see also under "Technical data"). Adverse ambient conditions, as for instance too high or too low ambient temperatures are not allowed, due to increased risk of an electronic parts breakdown.
3. Make sure the telephone, the connecting cable, etc. are not damaged. If the telephone is damaged, it may not be operated.
4. While the telephone is in operation please follow all relevant legal and professional regulations, the accident prevention regulations of the Employers' Liability Insurance Association, and laws and regulations governing the use and connection of electric devices.
5. In case of repairs, use only original spare parts. Replace such parts according to professional standards. Other spare parts may cause damage. The guarantee is rendered invalid.
6. Before the telephone is repaired or replaced, it must be disconnected from the power supply. If the maintenance or repair of a live device cannot be avoided, this must be done by authorised personnel only.
7. Do not damage the covers keeping the housing tight when mounting or demounting the device.
8. Take into consideration the required operating positions.
9. Magnetic fields with technical energy frequencies may cause an insignificant reduction in listening quality.
10. This product is subject to technical improvements without prior notice.

## Technical Data

Connection data		
Supply voltage	24...66 Vdc	
Supply current	19... 100 mA	
Ringing alternating current	30...90 Vac	
Ringing frequency	16...68 Hz	
Ringer input impedance	≥ 6.0 kΩ at 25 Hz ≥ 3.5 kΩ at 50 Hz	
Enquiry key (flash)	only for DTMF 80 ms, 120 ms, 600 ms	
Dialling mode		
DTMF	Frequencies according to ITU-T Q.23 Tone duration unlimited or 90 ms	
PD	Pulse/Pause ratio 1.5:1 (60/40 ms) or 2:1 (66.7/33.3 ms)	
Ringing volume	max. approx. 95 dB(A) at 1 m distance	
Housing (Height x Width x Depth)	293 x 191 x 128 mm	
Weight (telephone incl. telephone mount)	approx. 2.300 g	
Display	2 lines, 16 positions per row, 7x 5 matrix Pictograms	
Operating utilization position	Table or vertical wall mounting	
Handset		
Mouthpiece	Electret-foil microphone	
Receiver inset	dynamic receiver inset with magnetic field generator	
Connections	Single- or multiwired up to 2.5 mm <sup>2</sup>	
Labelling		
Power cable	TCP/La – TCP/Lb (TCP : Terminal Connection Point)	
Secondary sounder	W / W1	
Environmental conditions	without LCD	with LCD
Ambient operating temp.	-25°C...+55°C	-10°C...+50°C
Transport and storage temp.	-25°C...+70°C	-20°C...+60°C
Degree of protection acc. to IEC60529	IP65	

## EC Declaration of Conformity

J.Auer GmbH declares that the telephone FernTel 3 is in compliance with the basic demands and other relevant provisions of Directive 1999/5/EU (R&TTE).

This telephone is designed to be connected to public telecommunications exchanges and private branch exchanges, and complies with the basic demands according to EU Directive 1999/5/EG (Radio and Telecommunications Terminal Equipment, R&TTE).

If you experience problems during operation, please contact the J.Auer technical support service.



Electric and electronic devices carrying this symbol may contain substances harmful to people and the environment. Therefore, it must not be disposed of together with unsorted municipal waste (household rubbish). In order to protect the environment please use public collecting points for the disposal of electric and electronic devices carrying this symbol.



Subject to alterations or errors



Perfektastr. 102 · A-1230 Vienna  
Phone 0043 1 813 82 20 · Telefax 0043 1 815 99 54  
<http://www.auer-signal.com> · e-mail: [office@auer-signal.com](mailto:office@auer-signal.com)